

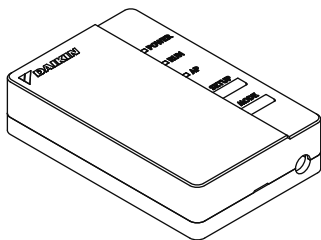

4P567679-1B

Wireless LAN Connecting Adapter
BRP069B82

Installation Manual



Homepage: <http://www.onlinecontroller.daikineurope.com>



- ◆ For details on specifications, installation instructions, setting methods, FAQ, copy of the original declaration of conformity and the latest version of this manual, see the above homepage.

- ◆ Hereby, Daikin Industries Czech Republic s.r.o. declares that the radio equipment type BRP069A42 is in compliance with Directive 2014/53/EU.

Accessories

Check if the following accessories are included in your package.

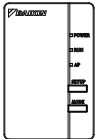
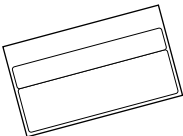
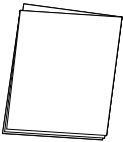
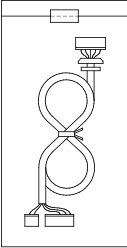
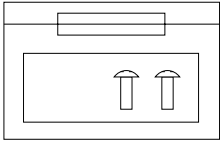
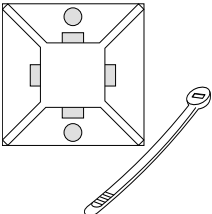
Model BRP069B82 ※1 Affix to the seal attachment on the back face of this sheet and store in a safe place.		
(A) Wireless LAN connecting adapter  BRP069A42	(B) Serial number seal (1 sheet) ※1 	(C) Installation manual (1pc) 
(D) Wire harness 	(E) Screws and adhesive tape 	(F) Cable tie with base 

Safety precautions

- ◆ The following describes the meanings of pictorial symbols used in this documentation.

Give this installation manual to the customer when installation is completed.

- ◆ To conduct a test run of the air conditioner, follow the installation manual for the air conditioner unit.



The protection of appliances marked with this symbol is ensured by double insulation and does not require a safety connection to electrical earth (ground).



Prohibited



Follow directions



Warning

Situations which could result in death or serious injury.

When installing:



- Request installation by your dealer or a technician.
(Can cause electric shock or fire.)
- Always use the accessories and specified parts for installation. Be sure to follow the directions in this installation manual.
(Can cause the unit to fall, electric shock or fire.)
- Electrical work should be carried out in accordance with the installation manual and the national electrical wiring rules or code of practice.
- Always turn off the power supply when installing.
(Touching the electrical parts can cause an electric shock.)
The main switch of the installation is on the outdoor unit.
Please switch off this main switch to turn off the power supply.

Safety precautions



Warning

Situations which could result in death or serious injury.

When using:



- Do not disassemble, modify, or repair.
(Can cause fire, electric shock or injury.)
- Do not handle this product with wet hands.
(Can cause electric shock or fire.)
- Do not allow this product to get wet or use it when bathing or doing similar activities with water.
(Can cause electric shock or fire.)
- Do not use this product near medical equipment or persons using cardiac pacemakers or defibrillators. This product may cause life-threatening electromagnetic interference.
- Do not use this product near auto-control equipment such as automatic doors or fire alarm equipment.
(Can cause accidents due to erroneous equipment behavior.)



-
- Immediately disconnect the air conditioner power plug if there is abnormal odor or sound, when it is overheating, or smoking.
(Can cause fire or malfunction.)
 - ◆ Request an inspection by your dealer.
 - Disconnect the air conditioner power plug if the product was dropped or the case is damaged.
(Can cause fire or electric shock)
 - ◆ Request an inspection by your dealer.

Safety precautions



Caution

Situations which could result in damage or physical injury.

When installing:



- Do not install where flammable gas leaks can occur.
(Can cause fire.)



- Grip the connector when disconnecting the connecting cord.
(Otherwise fire or electric shock can occur.)

When using:



- Do not use where small children can get access.
(Can cause injuries.)

- Do not use this product near a microwave oven.
(This can affect Wireless LAN communications.)

Disposal requirements



- Your product is marked with this symbol. This symbol means that electrical and electronic products shall not be mixed with unsorted household waste.
- Do not try to dismantle the system yourself: the dismantling of the product and of other parts must be done by a qualified installer in accordance with relevant local and national legislation.
- Product and waste must be treated at a specialized treatment facility for re-use, recycling and recovery.
- By ensuring correct disposal, you will help to prevent potential negative consequences for the environment and human health. Please contact the installer or local authority for more information.

Main components

Wireless LAN connecting adapter

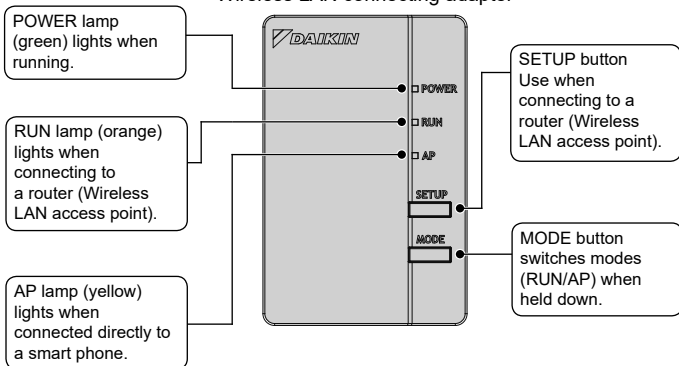

Main components

Basic parameters:

Frequency range:	2400 MHz~2483.5 MHz
Radio protocol:	IEEE 802.11b/g/n
RF channel:	1~11
Output power:	0 dBm~18 dBm
ERP:	17 dBm (11b) / 13 dBm (11g) / 12 dBm (11n)
Power supply:	DC 14 V / 16 V / 100 mA

RF channel: Radio frequency channel

ERP: Effective radiated power

FCAG*B, FCAHG*H

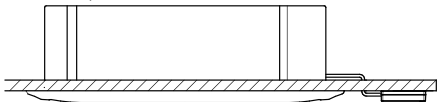

The indoor unit may differ from the illustration

Installation



Warning

Always turn off the power supply when installing. (Touching the electrical parts can cause an electric shock.) The main switch of the installation is at the outdoor unit.



ALWAYS connect a wired or wireless remote controller (e.g. BRC1E, BRC1H, BRC7), otherwise the online controller will NOT operate.

1 Choosing and installation site

- The WLAN adapter should be sited in a place where:
- The adapter is not in the path of direct sunlight.
- The adapter is away from the source of heat or steam.
- There is not source of machine oil vapour (this may shorten indoor unit life).
- The adapter is at least 1 m away from any television or radio set (unit may cause interference with the picture or sound).
- Distance between the indoor unit and the WLAN adapter is within length of WLAN cable.

2 Installation of WLAN wire harness to PCB of indoor unit

Connect wire harness (D) of WLAN adapter to connectors X35A and X50A on indoor unit PCB according to WLAN controller connection diagram.

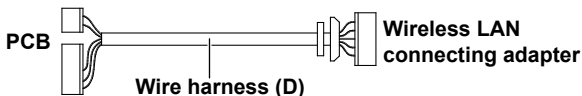

Installation

3 Connection Diagram

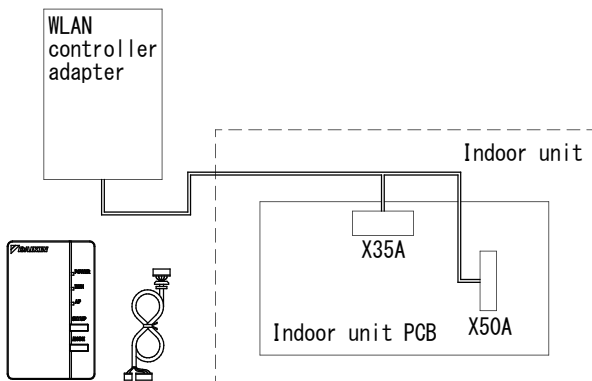

For more details about installation of WLAN adapter to your model please visit <http://www.onlinecontroller.daikineurope.com>.

Installation of wire harness to Wireless LAN adapter

1 Remove the adapter case (upper).

Press a regular screwdriver into the dent between the upper and lower cases to remove. (Be careful not to damage the case.)

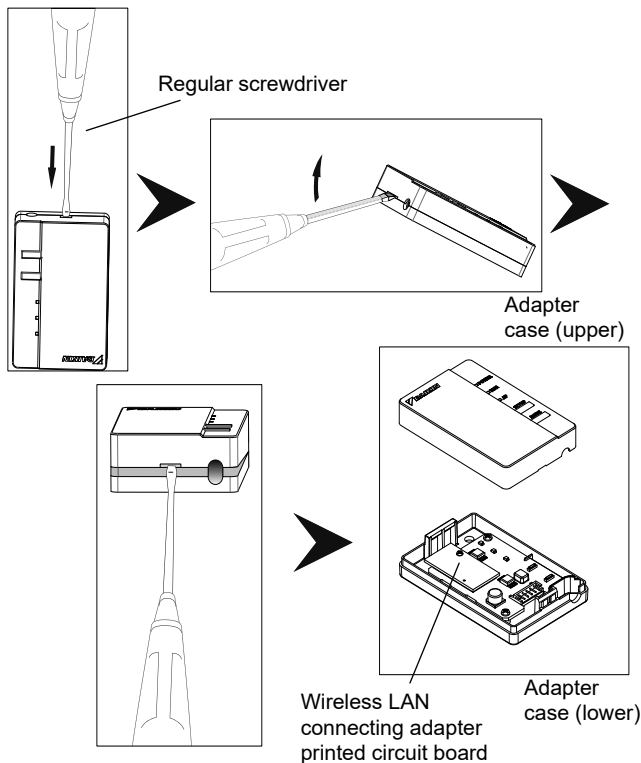

2 Attach connecting cord to the product.

Attach the connecting cord connector (white).

- ◆ Fasten the connecting cord to the notch in the adapter case (lower).
- ◆ Fix the WLAN adapter with screws on the wall before attaching upper case of the WLAN adapter.

Connect the connector to the same color.

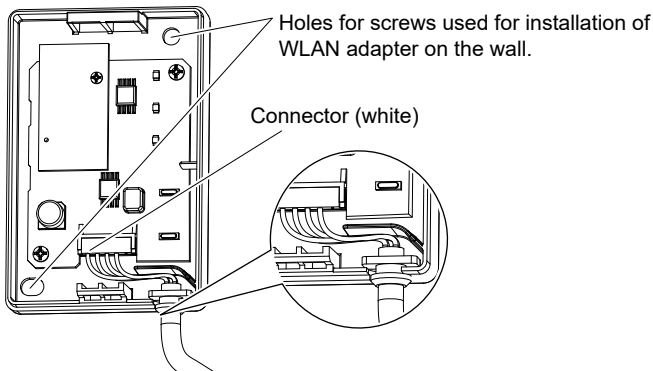

Fasten the connecting cord and ensure that external force is not transmitted.

For more details how to install WLAN adapter on the wall please visit <http://www.onlinecontroller.daikineurope.com>.

Installation

Installation Work

3 Return the adapter case to its original state.

Snap the top of the upper case onto the clip at the top of the lower case and press to close the box.

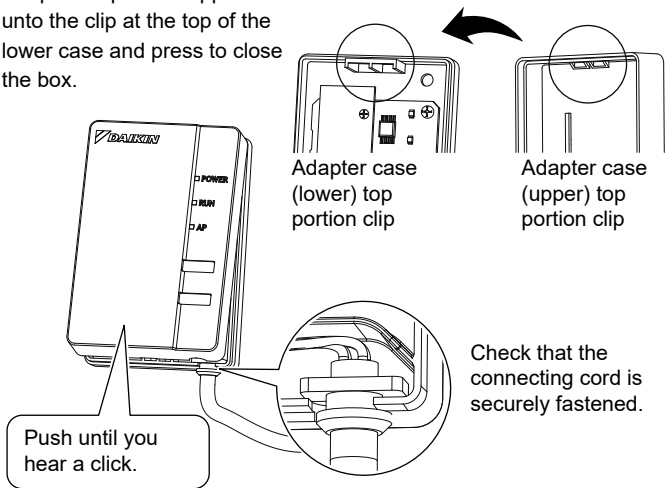

4 Functionality Check

Turn on the power supply and check that the [POWER] lamp for the product lights.

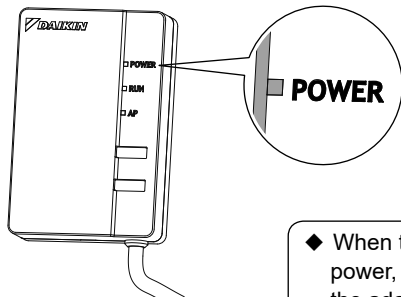

- ◆ When turning on the power, always attach the adapter case (top).

The customer is responsible for providing the following.

- Smartphone or tablet PC
(For minimum supported version of Android and iOS, please check <http://www.onlinecontroller.daikineurope.com>.)
- Internet line and communicating device
(Modem/router or similar device)
- Wireless LAN access point
- [Daikin online controller] (No cost)

Installation method of Daikin online controller

For Android Phones

- (1) Open the [Google Play].
- (2) Search for [Daikin online controller].
- (3) Follow the directions on the screen to install.

For iPhones

- (1) Open the [App Store].
- (2) Search for [Daikin online controller].
- (3) Follow the directions on the screen to install.

Refer to

<http://www.onlinecontroller.daikineurope.com>

for detailed installation instructions.

Troubleshooting

The following table provides brief descriptions of how to handle trouble or uncertainties when you install the product or make connection settings. Refer to the FAQ on the homepage for more details.

When this happens	Explanation and where to check
None of the LEDs light	<ul style="list-style-type: none">→ Try to operate the unit with the infrared remote controller.→ Turn off the air conditioner and restart it.→ Make sure the LEDs are not disabled in the application.→ Check the installation
The WLAN adapter is not visible on the unit overview screen ("Home" screen) after the WLAN adapter has been configured.	<ul style="list-style-type: none">→ Check that the power is on.→ Check that the RUN LED is lit.→ If the AP LED is lit, press the MODE button for two seconds to switch to RUN mode.→ If the RUN LED is blinking, retry to connect the WLAN adapter to the wireless network. Make sure the WLAN adapter is close enough to the router (wireless LAN access point).→ If the RUN LED is lit, make sure that the smartphone or tablet is connected to the same wireless LAN network as the WLAN adapter.

Troubleshooting

When this happens	Explanation and where to check
When trying to make a direct connection to the adapter (AP mode) the WLAN adapter is not visible in the available Wi-Fi networks list of the phone/tablet	<ul style="list-style-type: none">→ If the AP LED is not lit, press the "Mode" button for 2 seconds to switch to AP mode.→ If the AP LED is blinking, please wait until the AP LED is lit (approximately 1 minute). The WLAN adapter is still starting up.→ If the AP LED is lit, switch to RUN mode by pressing the MODE button for two seconds. Now switch back to AP mode by pressing the MODE button again for two seconds. This changes the wireless channel on which the WLAN adapter is operating. Repeat if necessary.
None of the above work	→ Refer to the FAQ on: http://www.onlinecontroller.daikineurope.com



DAIKIN INDUSTRIES CZECH REPUBLIC s.r.o.

U Nové Hospody 1/1155, 301 00 Plzeň Skvrňany, Czech Republic

DAIKIN EUROPE N.V.

Zandvoordestraat 300, B-8400 Oostende, Belgium

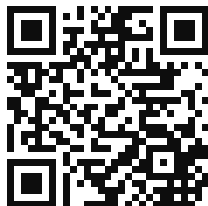

4P567679-1B 2020.01