

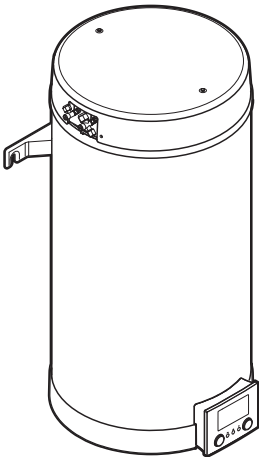

Installation manual

R32 Split series – Domestic hot water tank



EKHWET90B▲V3▼
EKHWET120B▲V3▼

▲ = 1, 2, 3, ..., 9, A, B, C, ..., Z
▼ = , , 1, 2, 3, ..., 9

Table of contents

1	About this document	2
2	Specific installer safety instructions	3
3	About the box	4
3.1	Indoor unit.....	4
3.1.1	To remove the accessories from the indoor unit.....	4
4	Unit installation	4
4.1	Preparing the installation site	4
4.1.1	Installation site requirements of the indoor unit	4
4.1.2	Special requirements for R32 units.....	4
4.1.3	Installation patterns.....	5
4.2	Opening and closing the unit.....	8
4.2.1	To open the indoor unit.....	8
4.2.2	To close the indoor unit.....	8
4.3	Mounting the indoor unit.....	9
4.3.1	To install the indoor unit.....	9
4.3.2	To connect the drain hose to the drain	9
5	Piping installation	9
5.1	Preparing refrigerant piping.....	9
5.1.1	Refrigerant piping requirements.....	9
5.2	Connecting refrigerant piping	9
5.2.1	To connect the refrigerant piping to the indoor unit	9
5.3	Preparing water piping.....	10
5.4	Connecting water piping.....	10
5.4.1	To connect the water piping.....	10
5.4.2	To fill the domestic hot water tank	10
6	Electrical installation	10
6.1	About electrical compliance.....	11
6.2	Specifications of standard wiring components	11
6.3	Guidelines when connecting the electrical wiring.....	11
6.4	Connections to the indoor unit.....	11
6.4.1	To connect the main power supply	11
6.4.2	To connect the booster heater power supply.....	11
6.4.3	To connect the WLAN cartridge (delivered as accessory).....	12
7	Configuration	12
7.1	Overview: Configuration	12
7.1.1	To access the most used commands	13
7.2	Configuration wizard.....	13
7.2.1	Configuration wizard: Language	13
7.2.2	Configuration wizard: Time and date	14
7.2.3	Configuration wizard: System	14
7.2.4	Configuration wizard: Tank	14
7.3	Weather-dependent curve.....	15
7.3.1	What is a weather-dependent curve?.....	15
7.3.2	2-points curve	15
7.3.3	Slope-offset curve	15
7.3.4	Using weather-dependent curves	16
7.4	Settings menu.....	16
7.4.1	Information.....	16
7.5	Menu structure: Overview installer settings.....	17
8	Commissioning	18
8.1	Checklist before commissioning	18
8.2	Checklist during commissioning	18
8.2.1	To perform an actuator test run	18
8.2.2	To perform an operation test run	18
9	Hand-over to the user	19
10	Technical data	20
10.1	Piping diagram: Indoor unit.....	20
10.2	Wiring diagram: Indoor unit	21

1 About this document

Target audience

Authorised installers

Documentation set

This document is part of a documentation set. The complete set consists of:

- **General safety precautions:**
 - Safety instructions that you must read before installing
 - Format: Paper (in the box of the indoor unit)
- **Operation manual:**
 - Quick guide for basic usage
 - Format: Paper (in the box of the indoor unit)
- **User reference guide:**
 - Detailed step-by-step instructions and background information for basic and advanced usage
 - Format: Digital files on <https://www.daikin.eu>. Use the search function 🔍 to find your model.
- **Installation manual – Outdoor unit:**
 - Installation instructions
 - Format: Paper (in the box of the outdoor unit)
- **Installation manual – Indoor unit:**
 - Installation instructions
 - Format: Paper (in the box of the indoor unit)
- **Installer reference guide:**
 - Preparation of the installation, good practices, reference data, ...
 - Format: Digital files on <https://www.daikin.eu>. Use the search function 🔍 to find your model.

The latest revision of the supplied documentation is published on the regional Daikin website and is available via your dealer.

The original instructions are written in English. All other languages are translations of the original instructions.

Technical engineering data

- A **subset** of the latest technical data is available on the regional Daikin website (publicly accessible).
- The **full set** of the latest technical data is available on the Daikin Business Portal (authentication required).

Online tools

In addition to the documentation set, some online tools are available for installers:

- **Heating Solutions Navigator**
 - Digital toolbox that offers a variety of tools to facilitate the installation and configuration of heating systems.
 - To access the Heating Solutions Navigator, registration to the Stand By Me platform is required. For more information, see <https://professional.standbyme.daikin.eu>.
- **Daikin e-Care**
 - Mobile app for installers and service technicians that allows you to register, configure and troubleshoot heating systems.
 - Use the QR codes below to download the mobile app for iOS and Android devices. Registration to the Stand By Me platform is required to access the app.

App Store



Google Play





2 Specific installer safety instructions

Always observe the following safety instructions and regulations.

Installation site (see ["4.1 Preparing the installation site"](#) [p 4])

 **WARNING**
The appliance shall be stored in a room without continuously operating ignition sources (example: open flames, an operating gas appliance or an operating electric heater).

 **WARNING**
DO NOT reuse refrigerant piping that has been used with any other refrigerant. Replace the refrigerant pipes or clean thoroughly.

 **WARNING**
Appliance is IPX3. When installing this product in a bathroom follow the applicable legislation for installation in such places.

 **WARNING**
Follow the service space dimensions in this manual to install the unit correctly. See ["4.1.1 Installation site requirements of the indoor unit"](#) [p 4].

Special requirements for R32 (see ["4.1.2 Special requirements for R32 units"](#) [p 4])

 **WARNING**

- Do NOT pierce or burn refrigerant cycle parts.
- Do NOT use means to accelerate the defrosting process or to clean the equipment, other than those recommended by the manufacturer.
- Be aware that R32 refrigerant does NOT contain an odour.

 **WARNING**
The appliance shall be stored so as to prevent mechanical damage and in a well-ventilated room without continuously operating ignition sources (example: open flames, an operating gas appliance or an operating electric heater).

 **WARNING**
Make sure installation, servicing, maintenance and repair comply with instructions from Daikin and with applicable legislation (for example national gas regulation) and are executed ONLY by authorised persons.

 **WARNING**
For units using the R32 refrigerant it is necessary to keep any required ventilation openings clear of obstructions.

Opening and closing the unit (see ["4.2 Opening and closing the unit"](#) [p 8])

 **DANGER: RISK OF ELECTROCUTION**

 **DANGER: RISK OF BURNING/SCALDING**

Mounting the indoor unit (see ["4.3 Mounting the indoor unit"](#) [p 9])

 **WARNING**
Fixing method of the indoor unit MUST be in accordance with the instructions from this manual. See ["4.3 Mounting the indoor unit"](#) [p 9].

Piping installation (see ["5 Piping installation"](#) [p 9])

 **WARNING**
Field piping MUST be in accordance with the instructions from this manual. See ["5 Piping installation"](#) [p 9].

 **CAUTION**

- When **mechanical** connectors are re-used indoors, renew the sealing parts.
- When **flared joints** are re-used indoors, re-make the flared part.

 **WARNING**
Do NOT install any valves between the domestic hot water tank and the pressure relief valve.

Electrical installation (see ["6 Electrical installation"](#) [p 10])

 **DANGER: RISK OF ELECTROCUTION**

 **WARNING**
Electrical wiring MUST be in accordance with the instructions from:

- This manual. See ["6 Electrical installation"](#) [p 10].
- The wiring diagram, which is delivered with the unit, located on the inside of the indoor unit switch box cover. For a translation of its legend, see ["10.2 Wiring diagram: Indoor unit"](#) [p 21].

 **WARNING**

- All wiring MUST be performed by an authorised electrician and MUST comply with the national wiring regulation.
- Make electrical connections to the fixed wiring.
- All components procured on-site and all electrical construction MUST comply with the applicable legislation.

 **WARNING**
If the supply cord is damaged, it MUST be replaced by the manufacturer, its service agent or similarly qualified persons in order to avoid a hazard.

 **WARNING**
ALWAYS use multicore cable for power supply cables.

 **CAUTION**
Do NOT push or place redundant cable length into the unit.

 **WARNING**
The booster heater MUST have a dedicated power supply and MUST be protected by the safety devices required by the applicable legislation.

 **CAUTION**
To guarantee the unit is completely earthed, ALWAYS connect the booster heater power supply and the earth cable.

 **INFORMATION**
For details on the fuse ratings, the fuse types and the circuit breaker ratings, see ["6 Electrical installation"](#) [p 10].

Commissioning (see ["8 Commissioning"](#) [p 18])

 **WARNING**
Commissioning MUST be in accordance with the instructions from this manual. See ["8 Commissioning"](#) [p 18].

3 About the box

3 About the box

Keep the following in mind:

- At delivery, the unit **MUST** be checked for damage and completeness. Any damage or missing parts **MUST** be reported immediately to the claims agent of the carrier.
- Bring the packed unit as close as possible to its final installation position to prevent damage during transport.
- Prepare in advance the path along which you want to bring the unit to its final installation position.

3.1 Indoor unit

3.1.1 To remove the accessories from the indoor unit

Some accessories are located inside the unit. For more information on opening the unit, see "4.2.1 To open the indoor unit" [p. 8].

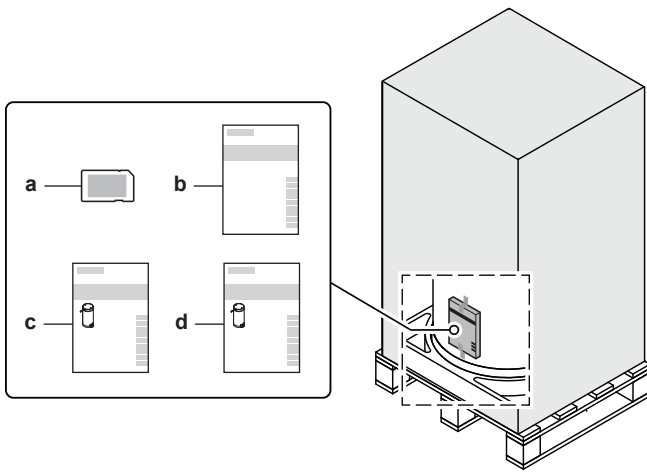

- a WLAN cartridge
- b General safety precautions
- c Operation manual
- d Indoor unit installation manual

4 Unit installation

4.1 Preparing the installation site



WARNING

The appliance shall be stored in a room without continuously operating ignition sources (example: open flames, an operating gas appliance or an operating electric heater).



WARNING

DO NOT reuse refrigerant piping that has been used with any other refrigerant. Replace the refrigerant pipes or clean thoroughly.



WARNING

Appliance is IPX3. When installing this product in a bathroom follow the applicable legislation for installation in such places.

4.1.1 Installation site requirements of the indoor unit

- The indoor unit is designed for indoor installation only and for ambient temperatures ranging from 5~35°C.
- Mind the following spacing installation guidelines:

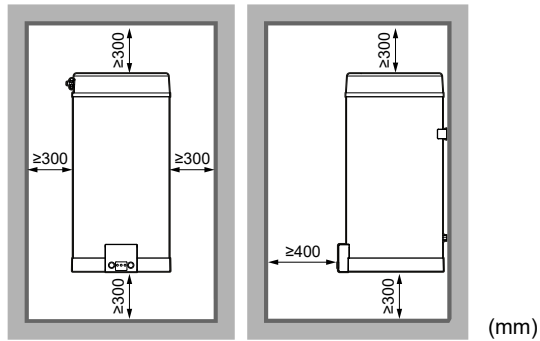

Additionally to the spacing guidelines: Because the total refrigerant charge in the system is ≥ 1.84 kg, the room where you install the indoor unit must also comply with the conditions described in "4.1.3 Installation patterns" [p. 5].

4.1.2 Special requirements for R32 units

Additionally to the spacing guidelines: Because the total refrigerant charge in the system is ≥ 1.84 kg, the room where you install the indoor unit must also comply with the conditions described in "4.1.3 Installation patterns" [p. 5].



WARNING

- Do NOT pierce or burn refrigerant cycle parts.
- Do NOT use means to accelerate the defrosting process or to clean the equipment, other than those recommended by the manufacturer.
- Be aware that R32 refrigerant does NOT contain an odour.



WARNING

The appliance shall be stored so as to prevent mechanical damage and in a well-ventilated room without continuously operating ignition sources (example: open flames, an operating gas appliance or an operating electric heater) and have a room size as specified below.



NOTICE

- Do NOT re-use joints and copper gaskets which have been used already.
- Joints made in the installation between parts of the refrigerant system shall be accessible for maintenance purposes.



WARNING

Make sure installation, servicing, maintenance and repair comply with instructions from Daikin and with applicable legislation (for example national gas regulation) and are executed **ONLY** by authorised persons.



NOTICE

- The pipework shall be securely mounted and guarded protected from physical damage.
- Keep the pipework installation to a minimum.

4.1.3 Installation patterns



WARNING

For units using the R32 refrigerant it is necessary to keep any required ventilation openings clear of obstructions.

Depending on the type of room in which you install the indoor unit, different installation patterns are allowed:

Room type	Allowed patterns
Living room, kitchen, garage, attic, basement, storage room	1, 2
Technical room (i.e. room that is NEVER occupied by persons)	1, 2, 3

	PATTERN 1	PATTERN 2	PATTERN 3
Ventilation openings	N/A	Between room A and B	Between room A and outside
Minimum floor area	Room A	Room A + Room B	N/A
Restrictions	See "PATTERN 1" [▶ 5], "PATTERN 2" [▶ 6], and "Tables for PATTERN 1 and 2" [▶ 7]		See "PATTERN 3" [▶ 8]

A	Room A (= room where indoor unit is installed)
B	Room B (= adjacent room)
c1	Bottom opening for natural ventilation
c2	Top opening for natural ventilation
H_{release}	Actual release height: From floor to 100 mm below top of the unit.
N/A	Not applicable

Minimum floor area / Release height:

- The minimum floor area requirements depend on the release height of the refrigerant in case of a leakage. The higher the release height, the lower the minimum floor area requirements.
- The default point of release is 100 mm below the top of the unit.
- You can also take advantage of the floor area of the adjacent room (= room B) by providing ventilation openings between the two rooms.
- For installations in technical rooms (i.e. room that is NEVER occupied by persons), additionally to patterns 1 and 2, you can also use **PATTERN 3**. For this pattern there are no requirements to the minimum floor area if you provide 2 openings (one at the bottom, one at the top) between the room and the outside to ensure natural ventilation. The room must be protected from frost.

PATTERN 1

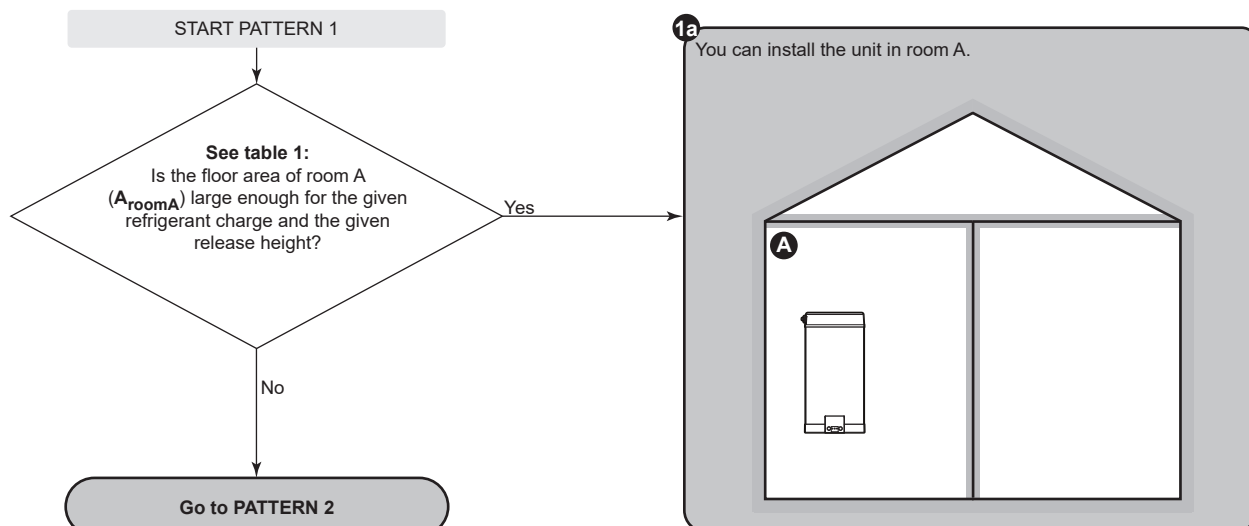

4 Unit installation

PATTERN 2

PATTERN 2: Conditions ventilation openings

If you want to take advantage of the floor area of the adjacent room, you must provide 2 openings (one at the bottom, one at the top) between the rooms to ensure natural ventilation. The openings must comply with the following conditions:

- **Bottom opening (A_{nv}):**
 - Must be a permanent opening that cannot be closed.
 - Must be completely located between 0 and 300 mm from the floor.
 - Must be $\geq A_{nv-min}$ (minimum bottom opening area).
 - $\geq 50\%$ of the required opening area A_{nv-min} must be ≤ 200 mm from the floor.
 - The bottom of the opening must be ≤ 100 mm from the floor.
 - If the opening starts from the floor, the height of the opening must be ≥ 20 mm.
- **Top opening:**
 - Must be a permanent opening that cannot be closed.
 - Must be $\geq 50\%$ of A_{nv-min} (minimum bottom opening area).
 - Must be ≥ 1.5 m from the floor.

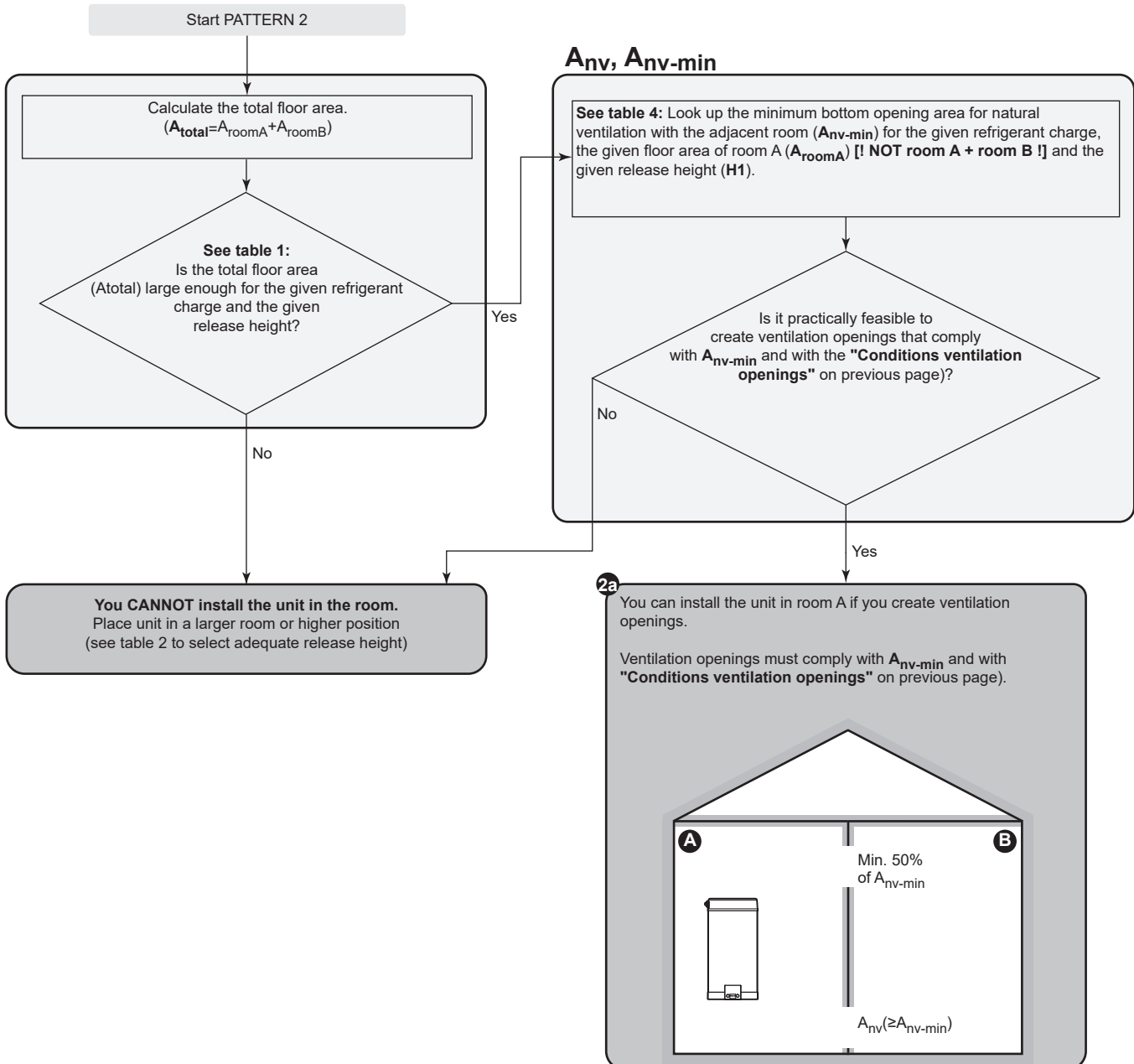
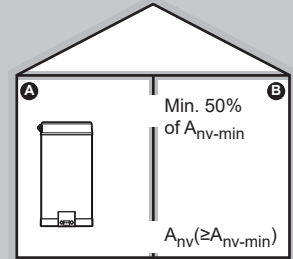

Tables for PATTERN 1 and 2

Table 1: Minimum floor area

Take the following into account:

- For intermediate floor areas, use the column with the lower value. **Example:** If the floor area is 1.7 m², use the column of 1.65 m².
- For intermediate refrigerant charges, use the row with the higher value. **Example:** If the refrigerant charge is 2.35 kg, use the row of 2.4 kg.

Charge (kg)	Minimum floor area (m ²)										
	Release height (m)										
	1,23	1,35	1,50	1,65	1,80	1,95	2,10	2,25	2,40	2,55	2,70
2.2	9,81	8,14	6,60	5,80	5,31	4,90	4,55	4,25	3,99	3,75	3,54
2.3	10,72	8,90	7,21	6,06	5,55	5,13	4,76	4,44	4,17	3,92	3,70
2.4	11,67	9,69	7,85	6,49	5,80	5,35	4,97	4,64	4,35	4,09	3,87
2.5	12,66	10,51	8,52	7,04	6,04	5,57	5,18	4,83	4,53	4,26	4,03
2.6	13,70	11,37	9,21	7,61	6,40	5,80	5,38	5,02	4,71	4,43	4,19

Table 2: Minimum release height

Take the following into account:

- For intermediate floor areas, use the column with the lower value. **Example:** If the floor area is 5 m², use the column of 4.00 m².
- For intermediate refrigerant charges, use the row with the higher value. **Example:** If the refrigerant charge is 2.35 kg, use the row of 2.4 kg.

Charge (kg)	Minimum release height (m)							
	Floor area (m ²)							
	2,00	4,00	6,00	8,00	10,00	12,00	14,00	
2.2	4,88	2,49	1,70	1,47	(*)	(*)	(*)	
2.3	5,10	2,60	1,77	1,53	1,38	(*)	(*)	
2.4	5,32	2,71	1,84	1,59	1,43	(*)	(*)	
2.5	5,53	2,82	1,91	1,65	1,49	1,37	(*)	
2.6	5,75	2,93	1,99	1,71	1,54	1,42	(*)	

Table 3: Minimum bottom opening area for natural ventilation

Take the following into account:

- Use the correct table. For intermediate refrigerant charges, use the table with the higher value. **Example:** If the refrigerant charge is 2.34 kg, use the table of 2.4 kg.
- For intermediate floor areas, use the column with the lower value. **Example:** If the floor area is 5 m², use the column of 4.00 m².
- For intermediate release height values, use the row with the lower value. **Example:** If the release height is 2.20 m, use the row of 2.05 m.
- A_{nv}: Bottom opening area for natural ventilation.
- A_{nv-min}: Minimum bottom opening area for natural ventilation.
- (*): Already OK (no ventilation openings needed).

Release height (m)	A _{nv-min} (dm ²) – In case of Refrigerant charge=2.2 kg							
	Floor area of room A (m ²) [! NOT room A + room B !]							
	2,00	4,00	6,00	8,00	10,00	12,00	14,00	
1.23	4,7	3,1	1,5	0,7	(*)	(*)	(*)	
1.45	4,0	2,3	0,6	(*)	(*)	(*)	(*)	
1.65	3,6	1,7	(*)	(*)	(*)	(*)	(*)	
1.85	3,2	1,2	(*)	(*)	(*)	(*)	(*)	
2.05	2,8	0,7	(*)	(*)	(*)	(*)	(*)	
2.25	2,5	0,3	(*)	(*)	(*)	(*)	(*)	
2.45	2,2	(*)	(*)	(*)	(*)	(*)	(*)	
2.65	1,9	(*)	(*)	(*)	(*)	(*)	(*)	

Release height (m)	A _{nv-min} (dm ²) – In case of Refrigerant charge=2.4 kg							
	Floor area of room A (m ²) [! NOT room A + room B !]							
	2,00	4,00	6,00	8,00	10,00	12,00	14,00	
1.23	5,2	3,6	2,0	1,3	0,6	(*)	(*)	
1.45	4,6	2,8	1,1	0,2	(*)	(*)	(*)	
1.65	4,1	2,2	0,3	(*)	(*)	(*)	(*)	
1.85	3,6	1,7	(*)	(*)	(*)	(*)	(*)	
2.05	3,2	1,2	(*)	(*)	(*)	(*)	(*)	
2.25	2,9	0,7	(*)	(*)	(*)	(*)	(*)	
2.45	2,6	0,3	(*)	(*)	(*)	(*)	(*)	
2.65	2,3	(*)	(*)	(*)	(*)	(*)	(*)	

Release height (m)	A _{nv-min} (dm ²) – In case of Refrigerant charge=2.6 kg							
	Floor area of room A (m ²) [! NOT room A + room B !]							
	2,00	4,00	6,00	8,00	10,00	12,00	14,00	
1.23	5,8	4,2	2,6	1,9	1,3	0,6	(*)	
1.45	5,1	3,3	1,6	0,8	(*)	(*)	(*)	
1.65	4,5	2,7	0,8	(*)	(*)	(*)	(*)	
1.85	4,1	2,1	0,2	(*)	(*)	(*)	(*)	
2.05	3,7	1,6	(*)	(*)	(*)	(*)	(*)	
2.25	3,3	1,2	(*)	(*)	(*)	(*)	(*)	

4 Unit installation

Release height (m)	A_{nv-min} (dm ²) – In case of Refrigerant charge=2.6 kg						
	Floor area of room A (m ²) [! NOT room A + room B !]						
	2,00	4,00	6,00	8,00	10,00	12,00	14,00
2.45	3,0	0,7	(*)	(*)	(*)	(*)	(*)
2.65	2,7	0,4	(*)	(*)	(*)	(*)	(*)

PATTERN 3

PATTERN 3 is only allowed for installations in technical rooms (i.e. room that is NEVER occupied by persons). For this pattern there are no requirements to the minimum floor area if you provide 2 openings (one at the bottom, one at the top) between the room and the outside to ensure natural ventilation. The room must be protected from frost.

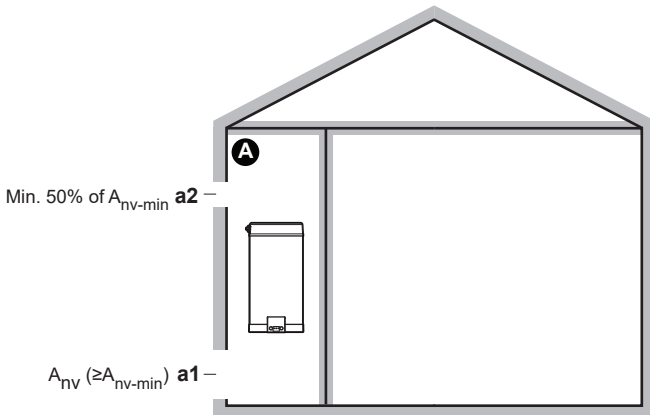

A	Unoccupied room where the indoor unit is installed. Must be protected from frost.
a1	<p>A_{nv}: Bottom opening for natural ventilation between the unoccupied room and the outside.</p> <ul style="list-style-type: none"> Must be a permanent opening that cannot be closed. Must be above ground level. Must be completely located between 0 and 300 mm from the floor of the unoccupied room. Must be $\geq A_{nv-min}$ (minimum bottom opening area as specified in the table below). $\geq 50\%$ of the required opening area A_{nv-min} must be ≤ 200 mm from the floor of the unoccupied room. The bottom of the opening must be ≤ 100 mm from the floor of the unoccupied room. If the opening starts from the floor, the height of the opening must be ≥ 20 mm.
a2	<p>Top opening for natural ventilation between room A and the outside.</p> <ul style="list-style-type: none"> Must be a permanent opening that cannot be closed. Must be $\geq 50\%$ of A_{nv-min} (minimum bottom opening area as specified in the table below). Must be ≥ 1.5 m from the floor of the unoccupied room.

A_{nv-min} (minimum bottom opening area for natural ventilation)

The minimum bottom opening area for natural ventilation between the unoccupied room and the outside depends on the total refrigerant in the system. For intermediate refrigerant charges, use the row with the higher value. **Example:** If the refrigerant charge is 2.55 kg, use the row of 2.6 kg.

Total refrigerant charge (kg)	A_{nv-min} (dm ²)
2.20	7.5
2.30	7.7
2.40	7.9
2.50	8.0
2.60	8.2

4.2 Opening and closing the unit

4.2.1 To open the indoor unit

- 1 Remove the bottom cover to be able to guide the cables to the switch box.

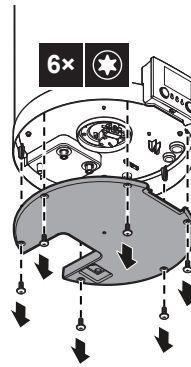

- 2 Remove the top cover.

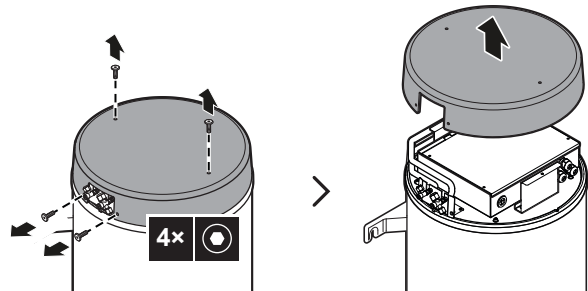

- 3 Remove the switch box cover.

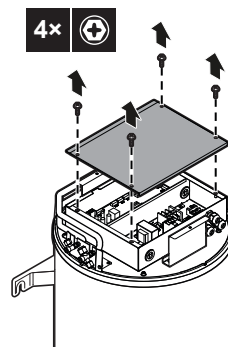

4.2.2 To close the indoor unit

- 1 Reinstall the switch box cover.
- 2 Reinstall the top cover.
- 3 Reinstall the bottom cover.



NOTICE

When closing the indoor unit cover, make sure that the tightening torque does NOT exceed 2.94 N•m.

4.3 Mounting the indoor unit

4.3.1 To install the indoor unit



NOTICE

Ensure that the wall on which it is mounted can support the weight of the appliance filled with water.

- 1 Install 2 plugs into the wall and insert (but not completely) 2 bolts with washers into the plugs.

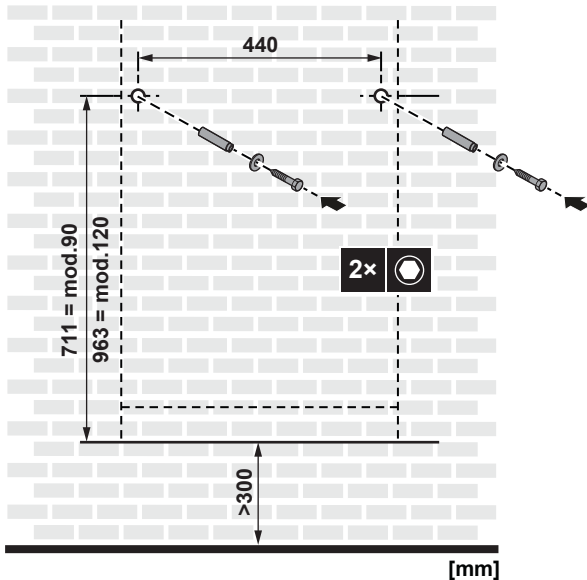

- 2 Lift the unit.

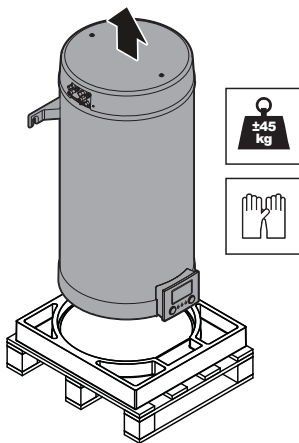

- 3 Attach the unit to the wall:

- Locate the bracket on the back of the unit above the 2 bolts.
- Lower the bracket on the back of the unit over the 2 bolts.
- Tighten the 2 bolts.
- Make sure the unit is fixed properly.

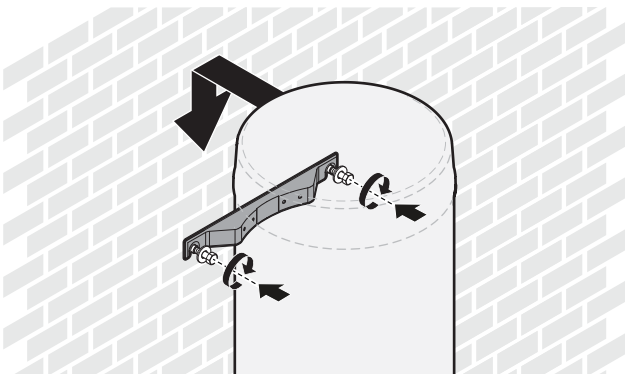

4.3.2 To connect the drain hose to the drain

Water coming from the pressure relief valve is collected in the drain pan. You must connect the drain pan to an appropriate drain according to the applicable legislation.

- 1 Connect a drain tube (field supply) to the drain pan connector as follows:

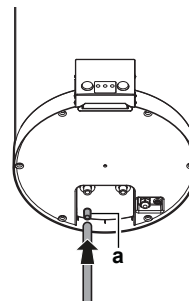

a Drain pan connector

5 Piping installation

5.1 Preparing refrigerant piping

5.1.1 Refrigerant piping requirements



CAUTION

- When **mechanical** connectors are re-used indoors, renew the sealing parts.
 - When **flared joints** are re-used indoors, re-make the flared part.
- **Piping connections:** Only flare and brazed connections are allowed. The indoor and outdoor units have flare connections. Connect both ends without brazing. If brazing should be needed, take the guidelines in the outdoor unit installer reference guide into account.

Also see "4.1.2 Special requirements for R32 units" [p. 4] for additional requirements.

For information related with piping length, diameter, connections and insulation see the Installation manual – Outdoor unit.

5.2 Connecting refrigerant piping

See the installation manual of the outdoor unit for all guidelines, specifications and installation instructions.

5.2.1 To connect the refrigerant piping to the indoor unit



NOTICE

Make sure the tank stop valves are completely open.



INFORMATION

The stop valves are factory open and the refrigerant circuit of the tank is NOT charged.

- 1 Connect refrigerant piping from the liquid stop valve of the outdoor unit to the refrigerant liquid stop valve of the indoor unit.

6 Electrical installation

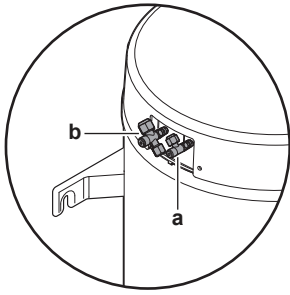

- a Refrigerant liquid stop valve
- b Refrigerant gas stop valve

- 2 Connect refrigerant piping from the gas stop valve of the outdoor unit to the refrigerant gas stop valve of the indoor unit.

5.3 Preparing water piping

NOTICE

In case of plastic pipes, make sure they are fully oxygen diffusion tight according to DIN 4726. The diffusion of oxygen into the piping can lead to excessive corrosion.

NOTICE

Water circuit requirements. Make sure to comply with the water pressure and water temperature requirements below. For additional water circuit requirements, see the installer reference guide.

- **Water pressure – Domestic hot water.** The maximum water pressure is 7 bar (=0.7 MPa), and must be in accordance with the applicable legislation. Provide adequate safeguards in the water circuit to ensure that the maximum pressure is NOT exceeded (see "5.4.1 To connect the water piping" [p 10]). The minimum water pressure to operate is 1 bar (=0.1 MPa).
- **Water temperature.** All installed piping and piping accessories (valve, connections,...) MUST withstand the following temperatures:

INFORMATION

The following figure is an example and may NOT completely match your system layout.

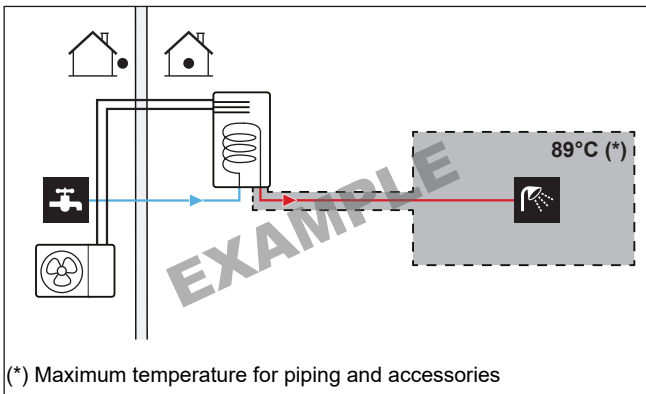

(*) Maximum temperature for piping and accessories

5.4 Connecting water piping

5.4.1 To connect the water piping

NOTICE

Do NOT use excessive force when connecting the field piping and make sure the piping is aligned properly. Deformed pipes can cause the unit to malfunction.

- 1 Connect the domestic hot water in and out pipes to the indoor unit.

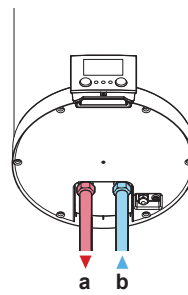

- a DHW – hot water OUT (screw connection, 1/2")
- b DHW – cold water IN (screw connection, 1/2")

- 2 Install the following components (field supply) on the cold water inlet of the DHW tank:

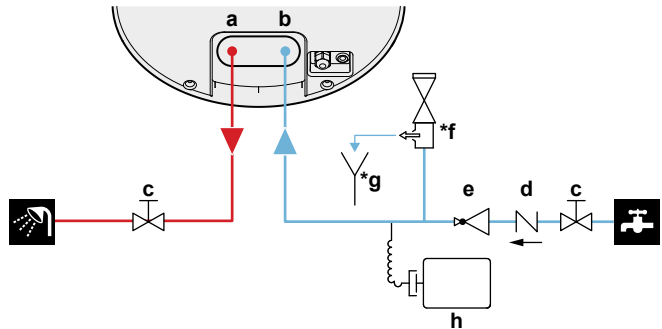

- a DHW – hot water OUT (screw connection, 1/2")
- b DHW – cold water IN (screw connection, 1/2")
- c Shut-off valve (recommended)
- d Non-return valve (recommended)
- e Pressure reducing valve (recommended)
- *f Pressure relief valve (max. 7 bar (=0.7 MPa))(mandatory)
- *g Tundish (mandatory)
- h Expansion vessel (recommended)

WARNING

Do NOT install any valves between the domestic hot water tank and the pressure relief valve.

NOTICE

A pressure relief valve (field supply) with an opening pressure of maximum 7 bar (=0.7 MPa) must be installed on the domestic cold water inlet connection in accordance with the applicable legislation.

NOTICE

To avoid damage to the surroundings in case of water leakage, it is recommended to close the domestic cold water inlet shut-off valves during periods of absence.

5.4.2 To fill the domestic hot water tank

- 1 Open every hot water tap in turn to purge air from the system pipe work.
- 2 Open the cold water supply valve.
- 3 Close all water taps after all air is purged.
- 4 Check for water leaks.
- 5 Manually operate the field-installed pressure relief valve to ensure a free water flow through the discharge pipe.

6 Electrical installation

DANGER: RISK OF ELECTROCUTION

WARNING

ALWAYS use multicore cable for power supply cables.

6.1 About electrical compliance

Only for the booster heater of the indoor unit

See "6.4.2 To connect the booster heater power supply" [11].

6.2 Specifications of standard wiring components



NOTICE

We recommend using solid wires. If stranded wires are used, slightly twist the strands to consolidate the end of the conductor for either direct use in the terminal clamp or insertion in a round crimp-style terminal. Details are described in "Guidelines when connecting the electrical wiring" in the installer reference guide.

Component		
Interconnection cable (indoor↔outdoor)	Voltage	220~240 V
	Wire size	Only use harmonized wire providing double insulation and suitable for applicable voltage 4-core cable Minimum 1.5 mm ²
Booster heater power supply	Voltage	220~240 V
	Wire size	Only use harmonized wire providing double insulation and suitable for applicable voltage 3-core cable Minimum 1.5 mm ²
	Recommended field fuse	10 A, C curve
	Earth leakage circuit breaker / residual current device	30 mA – MUST comply with national wiring regulation

6.3 Guidelines when connecting the electrical wiring

Tightening torques

Indoor unit:

Item	Tightening torque (N·m)
X2M	2.45 ±10%
X5M	0.88 ±10%
X8M	2.45 ±10%
M4 (earth)	1.47 ±10%

6.4 Connections to the indoor unit

Item	Description
Power supply (main)	See "6.4.1 To connect the main power supply" [11].
Power supply (booster heater)	See "6.4.2 To connect the booster heater power supply" [11].
WLAN cartridge	See "6.4.3 To connect the WLAN cartridge (delivered as accessory)" [12]

6.4.1 To connect the main power supply

- 1 Open the following (see "4.2.1 To open the indoor unit" [8]):

- 2 Connect the main power supply.

	Interconnection cable (= main power supply)	Wires: (3+GND)×1.5 mm ²
	[9.4]Booster heater	

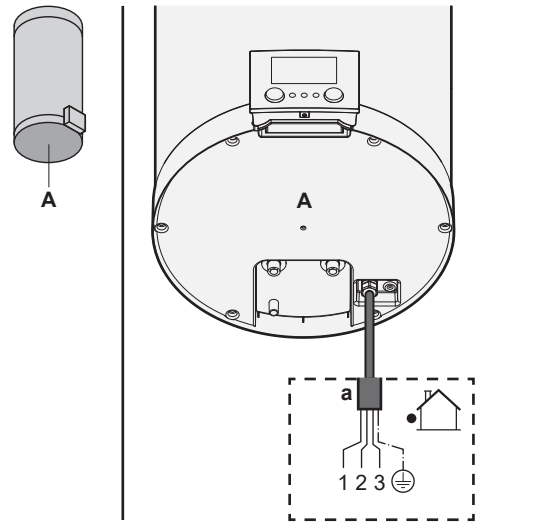

a Interconnection cable (=main power supply)

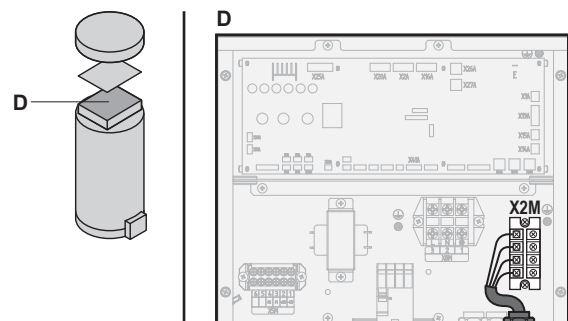
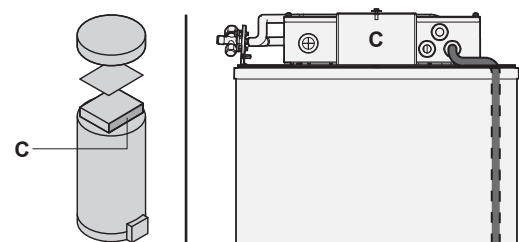
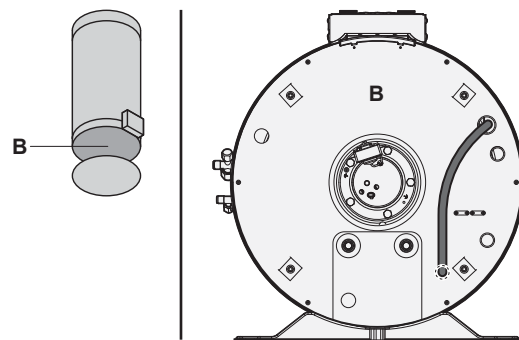

6.4.2 To connect the booster heater power supply

	Booster heater cable	Wires: (2+GND)×1.5 mm ²
	[9.4]Booster heater	

7 Configuration

WARNING

The booster heater **MUST** have a dedicated power supply and **MUST** be protected by the safety devices required by the applicable legislation.

CAUTION

To guarantee the unit is completely earthed, **ALWAYS** connect the booster heater power supply and the earth cable.

Connect the booster heater power supply as follows:

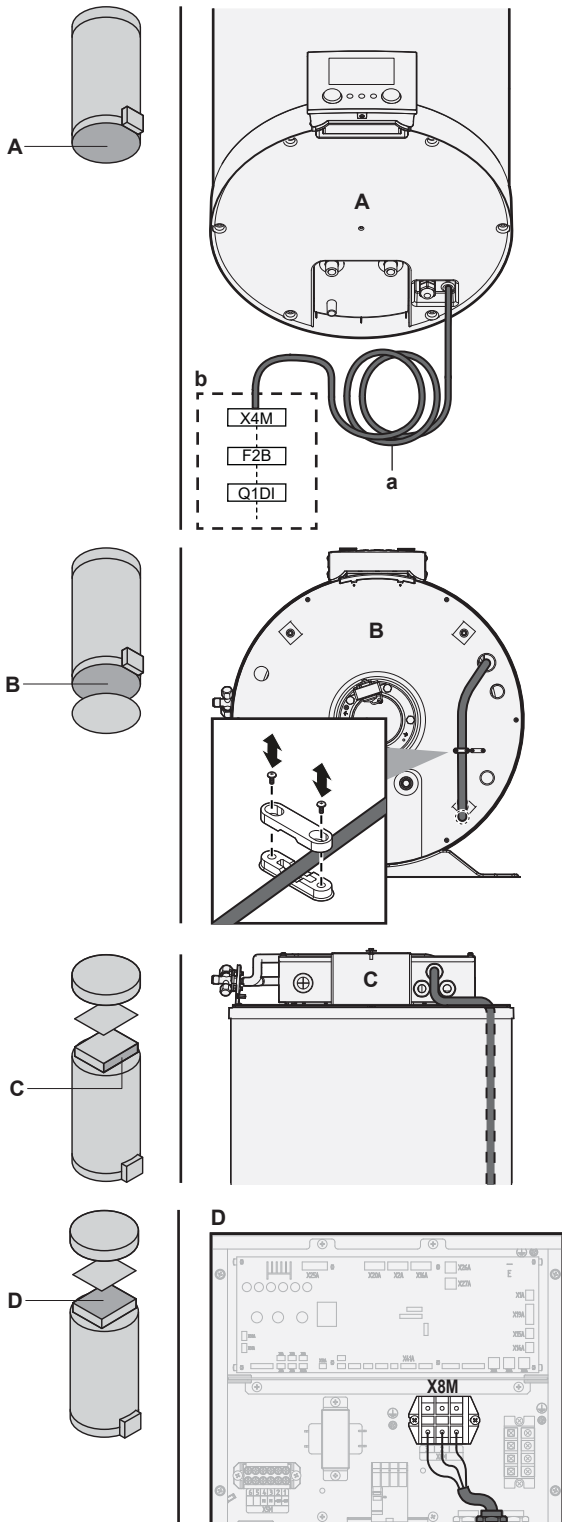

a Booster heater power supply cable

b Field wiring

6.4.3 To connect the WLAN cartridge (delivered as accessory)

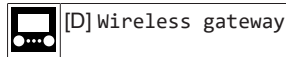

- 1 Insert the WLAN cartridge into the cartridge slot on the user interface of the indoor unit.

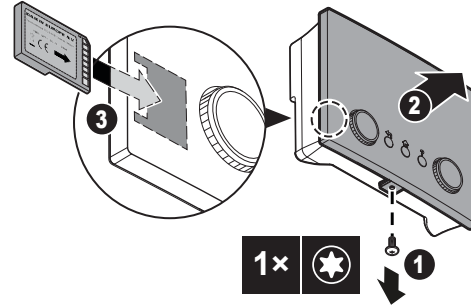

See the installer reference guide for more information.

7 Configuration

7.1 Overview: Configuration

This chapter describes what you have to do and know to configure the system after it is installed.

NOTICE

This chapter explains only the basic configuration. For more detailed explanation and background information, see the installer reference guide.

Why

If you do NOT configure the system correctly, it might NOT work as expected. The configuration influences the following:

- The calculations of the software
- What you can see on and do with the user interface

How

You can configure the system via the user interface.

- **First time – Configuration wizard.** When you turn ON the user interface for the first time (via the unit), the configuration wizard starts to help you configure the system.
- **Restart the configuration wizard.** If the system is already configured, you can restart the configuration wizard. To restart the configuration wizard, go to Installer settings > Configuration wizard. To access Installer settings, see "7.1.1 To access the most used commands" [p 13].
- **Afterwards.** If necessary, you can make changes to the configuration in the menu structure or the overview settings.

INFORMATION

When the configuration wizard is finished, the user interface will show an overview screen and request to confirm. When confirmed, the system will restart and the home screen will be displayed.

Accessing settings – Legend for tables

You can access the installer settings using two different methods. However, NOT all settings are accessible via both methods. If so, the corresponding table columns in this chapter are set to N/A (not applicable).

Method	Column in tables
Accessing settings via the breadcrumb in the home menu screen or the menu structure . To enable breadcrumbs, press the ? button in the home screen.	# For example: [5.5]
Accessing settings via the code in the overview field settings .	Code For example: [6-0D]

See also:

- "To access the installer settings" [▶ 13]
- "7.5 Menu structure: Overview installer settings" [▶ 17]

7.1.1 To access the most used commands

To change the user permission level

You can change the user permission level as follows:

1	Go to [B]: User profile.	
2	Enter the applicable pin code for the user permission level.	—
	<ul style="list-style-type: none"> • Browse through the list of digits and change the selected digit. 	
	<ul style="list-style-type: none"> • Confirm the digit to proceed to the next digit. 	
	OR, move the cursor from left to right.	
	• Confirm the pin code and proceed.	

Installer pin code

The Installer pin code is **5678**. Additional menu items and installer settings are now available.

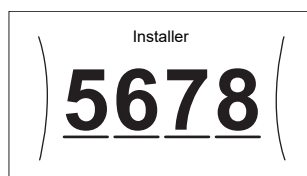

Advanced user pin code

The Advanced user pin code is **1234**. Additional menu items for the user are now visible.

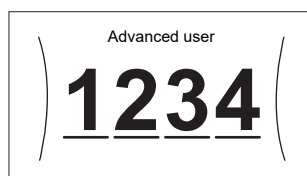

User pin code

The User pin code is **0000**.

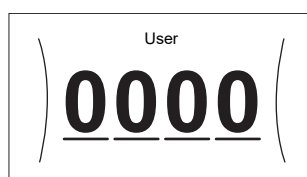

To access the installer settings

- 1 Set the user permission level to Installer.

- 2 Go to [9]: Installer settings.

To modify an overview setting

Example: Modify [2-02] from 23 to 3.

Most settings can be configured via the menu structure. If for any reason it is required to change a setting using the overview settings, then the overview settings can be accessed as follows:

1	Set the user permission level to Installer. See " To change the user permission level " [▶ 13].	—
2	Go to [9.I]: Installer settings > Overview field settings.	
3	Turn the left dial to select the first part of the setting and confirm by pressing the dial.	
4	Turn the left dial to select the second part of the setting	
5	Turn the right dial to modify the value from 23 to 3.	
6	Press the left dial to confirm the new setting.	
7	Press the center button to go back to the home screen.	

INFORMATION

When you change the overview settings and you go back to the home screen, the user interface will show a popup screen and request to restart the system.

When confirmed, the system will restart and recent changes will be applied.

7.2 Configuration wizard

After first power ON of the system, the user interface starts a configuration wizard. Use this wizard to set the most important initial settings for the unit to run properly. If required, you can afterwards configure more settings. You can change all these settings via the menu structure.

Protective functions

The unit is equipped with the following protective function:

- Tank disinfection [2-01]

The unit automatically runs the protective function when necessary. During installation or service, this behaviour is undesired. Therefore, the protective function can be disabled.

7.2.1 Configuration wizard: Language

#	Code	Description
[7.1]	N/A	Language

7 Configuration

7.2.2 Configuration wizard: Time and date

#	Code	Description
[7.2]	N/A	Set the local time and date



INFORMATION

By default, daylight savings time is enabled and clock format is set to 24 hours. These settings can be changed during initial configuration or via the menu structure [7.2]: User settings > Time/date.

7.2.3 Configuration wizard: System

Indoor unit type

The indoor unit type is displayed, but cannot be adjusted.

Domestic hot water

The tank type is displayed, but cannot be adjusted.

Emergency

When the heat pump fails to operate, the booster heater can serve as an emergency heater. It then takes over the heat load either automatically or by manual interaction.

- When Emergency is set to Automatic and a heat pump failure occurs, the booster heater in the tank automatically takes over the domestic hot water production.
- When Emergency is set to Manual and a heat pump failure occurs, the domestic hot water heating stops.

To manually recover it via the user interface, go to the Malfunctioning main menu screen and confirm whether the booster heater can take over the heat load or not.

To keep energy consumption low, we recommend to set Emergency to Manual if the house is unattended for longer periods.

#	Code	Description
[9.5.1]	[4-06]	<ul style="list-style-type: none"> 0: Manual 1: Automatic



INFORMATION

The auto emergency setting can be set in the menu structure of the user interface only.



INFORMATION

If a heat pump failure occurs and Emergency is set to Manual, the disinfection function will be activated ONLY if the user confirms emergency operation via the user interface.

Booster heater capacity

The capacity of the booster heater must be set for the power consumption control feature to work properly. When measuring the resistance value of the booster heater, you can set the exact heater capacity and this will lead to more accurate energy data (e.g. for Power consumption control). The capacity of the booster heater installed in the domestic hot water tank is 1,2 kW.

#	Code	Description
[9.4.1]	[6-02]	Booster heater capacity [kW]. The capacity of the booster heater at nominal voltage. Range: 0~10 kW

7.2.4 Configuration wizard: Tank

Heat up mode

The domestic hot water can be prepared in 3 different ways. They differ from each other by the way the desired tank temperature is set and how the unit acts upon it.

#	Code	Description
[5.6]	[6-0D]	Heat up mode: <ul style="list-style-type: none"> 0: Reheat only: Only reheat operation is allowed. 1: Schedule + reheat: The domestic hot water tank is heated according to a schedule and between the scheduled heat up cycles, reheat operation is allowed. 2: Schedule only: The domestic hot water tank can ONLY be heated according to a schedule.

See the operation manual for more details.

Settings for Reheat only mode

During Reheat only mode, the tank setpoint can be set on the user interface. The maximum allowed temperature is determined by the following setting:

#	Code	Description
[5.8]	[6-0E]	Maximum: The maximum temperature that users can select for the domestic hot water. You can use this setting to limit the temperature at the hot water taps. The maximum temperature is NOT applicable during disinfection function.

To set the heat pump ON hysteresis:

#	Code	Description
[5.9]	[6-00]	Heat pump ON hysteresis <ul style="list-style-type: none"> 2°C~20°C

Settings for Schedule only mode and Schedule + reheat mode

Comfort setpoint

Only applicable when domestic hot water preparation is Schedule only or Schedule + reheat. When programming the schedule, you can make use of the comfort setpoint as a preset value. When you later want to change the storage setpoint, you only have to do it in one place.

The tank will heat up until the **storage comfort temperature** has been reached. It is the higher desired temperature when a storage comfort action is scheduled.

Additionally, a storage stop can be programmed. This feature puts a stop to tank heating even if the setpoint has NOT been reached. Only program a storage stop when tank heating is absolutely undesirable.

#	Code	Description
[5.2]	[6-0A]	Comfort setpoint: <ul style="list-style-type: none"> 30°C~[6-0E]°C

Eco setpoint

The **storage economic temperature** denotes the lower desired tank temperature. It is the desired temperature when a storage economic action is scheduled (preferably during day).

#	Code	Description
[5.3]	[6-0B]	Eco setpoint: <ul style="list-style-type: none"> 30°C~min(50,[6-0E])°C

Reheat setpoint

Desired reheat tank temperature, used in Schedule + reheat mode, during reheat mode: the guaranteed minimum tank temperature is set by the Reheat setpoint minus the reheat hysteresis. If the tank temperature drops below this value, the tank is heated up.

#	Code	Description
[5.4]	[6-0C]	Reheat setpoint: ▪ $30^{\circ}\text{C} \sim \min(50, [6-0E])^{\circ}\text{C}$

Hysteresis (reheat hysteresis)

Applicable when domestic hot water preparation is scheduled+reheat. When the tank temperature drops below the reheat temperature minus the reheat hysteresis temperature, the tank heats up to the reheat temperature.

#	Code	Description
[5.A]	[6-08]	Reheat hysteresis ▪ $2^{\circ}\text{C} \sim 20^{\circ}\text{C}$



INFORMATION

To ensure most optimum operation of the outdoor unit, we recommend to set the hysteresis to 6°C or higher.



INFORMATION

If Reheat setpoint is outside operation range of the outdoor unit, then the hysteresis will refer to the the highest temperature achievable by heat pump operation.

7.3 Weather-dependent curve

7.3.1 What is a weather-dependent curve?

Weather-dependent operation

The unit operates 'weather-dependent' if the desired tank temperature is determined automatically by the outdoor temperature. If the outdoor temperature drops or rises, the unit compensates instantly. Thus, the unit does not have to wait for feedback by the user to increase or decrease the target temperature of the tank. Because it reacts more quickly, it prevents high rises and drops of the water temperature at tap points.

Advantage

Weather-dependent operation reduces energy consumption.

Weather-dependent curve

To be able to compensate for differences in temperature, the unit relies on its weather-dependent curve. This curve defines how much the target temperature of the tank must be at different outdoor temperatures. Because the slope of the curve depends on local circumstances such as climate and the insulation of the house, the curve can be adjusted by an installer.

Types of weather-dependent curve

There are 2 types of weather-dependent curves:

- 2-points curve
- Slope-offset curve

Which type of curve you use to make adjustments, depends on your personal preference. See "7.3.4 Using weather-dependent curves" [p 16].

Availability

The weather-dependent curve is available for:

- Tank (only available to installers)



INFORMATION

To operate weather-dependent, correctly configure the setpoint of the tank. See "7.3.4 Using weather-dependent curves" [p 16].

7.3.2 2-points curve

Define the weather-dependent curve with these two setpoints:

- Setpoint (X1, Y2)

- Setpoint (X2, Y1)

Example

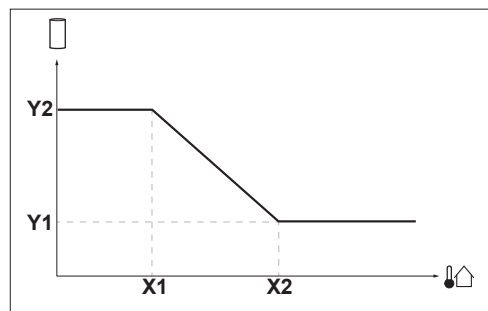

Item	Description
X1, X2	Examples of outdoor ambient temperature
Y1, Y2	Examples of desired tank temperature. The icon corresponds to the heat emitter for that zone: ▪ : Domestic hot water tank

Possible actions on this screen

	Go through the temperatures.
	Change the temperature.
	Go to the next temperature.
	Confirm changes and proceed.

7.3.3 Slope-offset curve

Slope and offset

Define the weather-dependent curve by its slope and offset:

- Change the **slope** to differently increase or decrease the target temperature of the tank for different ambient temperatures. For example, if tank water temperature is in general fine but at low ambient temperatures too cold, raise the slope so that the tank temperature is heated increasingly more at decreasingly lower ambient temperatures.
- Change the **offset** to equally increase or decrease the target temperature of the tank for different ambient temperatures. For example, if the tank temperature is always a bit too cold at different ambient temperatures, shift the offset up to equally increase the tank target temperature for all ambient temperatures.

Examples

Weather-dependent curve when slope is selected:

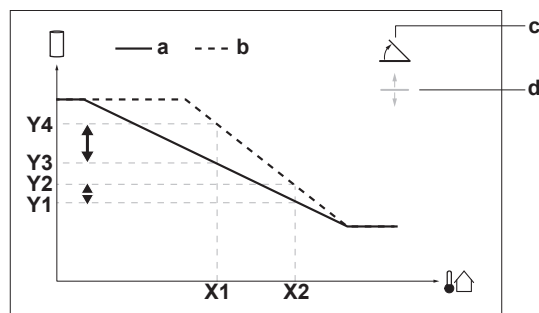

Weather-dependent curve when offset is selected:

7 Configuration

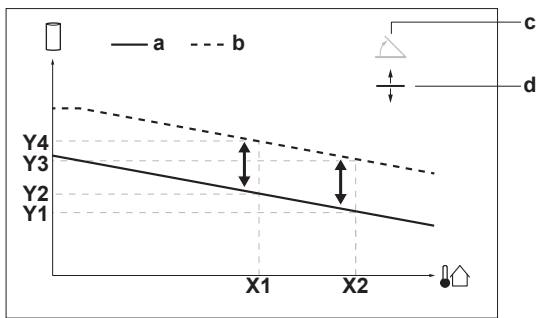

Item	Description
a	WD curve before changes.
b	WD curve after changes (as example): <ul style="list-style-type: none"> When slope is changed, the new preferred temperature at X1 is unequally higher than the preferred temperature at X2. When offset is changed, the new preferred temperature at X1 is equally higher as the preferred temperature at X2.
c	Slope
d	Offset
X1, X2	Examples of outdoor ambient temperature
Y1, Y2, Y3, Y4	Examples of desired tank temperature. The icon corresponds to the heat emitter for that zone: <ul style="list-style-type: none"> : Domestic hot water tank

Possible actions on this screen	
	Select slope or offset.
	Increase or decrease the slope/offset.
	When slope is selected: set slope and go to offset. When offset is selected: set offset.
	Confirm changes and return to the submenu.

7.3.4 Using weather-dependent curves

Configure weather-dependent curves as following:

To define the setpoint mode

To use the weather-dependent curve, you need to define the correct setpoint mode:

Go to setpoint mode ...	Set the setpoint mode to ...
Tank	
[5.B] Tank > Setpoint mode	Restriction: Only available to installers. Weather dependent

To change the type of weather-dependent curve

To change the type for the tank, go to [5.E] Tank.

- [5.E] Tank > WD curve type

Restriction: Only available to installers.

To change the weather-dependent curve

Zone	Go to ...
Tank	Restriction: Only available to installers. [5.C] Tank > WD curve

INFORMATION

Maximum and minimum setpoints

You cannot configure the curve with temperatures that are higher or lower than the set maximum and minimum setpoints for the tank. When the maximum or minimum setpoint is reached, the curve flattens out.

To fine-tune the weather-dependent curve: slope-offset curve

The following table describes how to fine-tune the weather-dependent curve of the tank:

The domestic hot water temperature is ...		Fine-tune with slope and offset:	
At regular outdoor temperatures ...	At cold outdoor temperatures ...	Slope	Offset
OK	Cold	↑	—
OK	Hot	↓	—
Cold	OK	↓	↑
Cold	Cold	—	↑
Cold	Hot	↓	↑
Hot	OK	↑	↓
Hot	Cold	↑	↓
Hot	Hot	—	↓

See "7.3.3 Slope-offset curve" [p 15].

To fine-tune the weather-dependent curve: 2-points curve

The following table describes how to fine-tune the weather-dependent curve of the tank:

The domestic hot water temperature is ...		Fine-tune with setpoints:			
At regular outdoor temperatures ...	At cold outdoor temperatures ...	Y2 ^(a)	Y1 ^(a)	X1 ^(a)	X2 ^(a)
OK	Cold	↑	—	↑	—
OK	Hot	↓	—	↓	—
Cold	OK	—	↑	—	↑
Cold	Cold	↑	↑	↑	↑
Cold	Hot	↓	↑	↓	↑
Hot	OK	—	↓	—	↓
Hot	Cold	↑	↓	↑	↓
Hot	Hot	↓	↓	↓	↓

^(a) See "7.3.2 2-points curve" [p 15].

7.4 Settings menu

You can set additional settings using the main menu screen and its submenus. The most important settings are presented here.

7.4.1 Information

Dealer information

The installer can fill in his contact number here.

#	Code	Description
[8.3]	N/A	Number that users can call in case of problems.

7.5 Menu structure: Overview installer settings

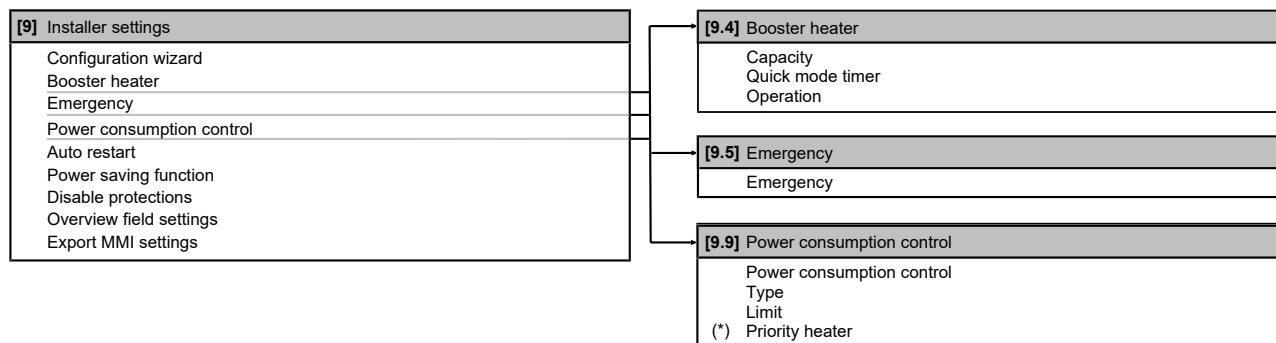

(*) Can NOT be adjusted



INFORMATION

Depending on the selected installer settings and unit type, settings will be visible/invisible.

8 Commissioning

8 Commissioning



NOTICE

General commissioning checklist. Next to the commissioning instructions in this chapter, a general commissioning checklist is also available on the Daikin Business Portal (authentication required).

The general commissioning checklist is complementary to the instructions in this chapter and can be used as a guideline and reporting template during commissioning and hand-over to the user.



NOTICE

ALWAYS operate the unit with thermistors and/or pressure sensors/switches. If NOT, burning of the compressor might be the result.



INFORMATION

Protective functions – "Installer-on-site mode". The software is equipped with protective functions, such as tank disinfection. The unit automatically runs these functions when necessary.

During installation or service this behaviour is undesired. Therefore, the protective functions can be disabled:

- **At first power-on:** The protective functions are disabled by default. After 36 hours they will be automatically enabled.
- **Afterwards:** An installer can manually disable the protective functions by setting [9.G]: Disable protections=Yes. After his work is done, he can enable the protective functions by setting [9.G]: Disable protections=No.

Also see "Protective functions" [▶ 13].

8.1 Checklist before commissioning

- 1 After the installation of the unit, check the items listed below.
- 2 Close the unit.
- 3 Power up the unit.

<input type="checkbox"/>	You read the complete installation instructions, as described in the installer reference guide .
<input type="checkbox"/>	The indoor unit is properly mounted.
<input type="checkbox"/>	The outdoor unit is properly mounted.
<input type="checkbox"/>	The following field wiring has been carried out according to this document and the applicable legislation: <ul style="list-style-type: none"> ▪ Between the local supply panel and the outdoor unit ▪ Between indoor unit and outdoor unit ▪ Between the local supply panel and the indoor unit
<input type="checkbox"/>	The system is properly earthed and the earth terminals are tightened.
<input type="checkbox"/>	The fuses or locally installed protection devices are installed according to this document, and have NOT been bypassed.
<input type="checkbox"/>	The power supply voltage matches the voltage on the identification label of the unit.
<input type="checkbox"/>	There are NO loose connections or damaged electrical components in the switch box.
<input type="checkbox"/>	There are NO damaged components or squeezed pipes on the inside of the indoor and outdoor units.
<input type="checkbox"/>	Booster heater circuit breaker F2B (field supply) is turned ON.

<input type="checkbox"/>	There are NO refrigerant leaks .
<input type="checkbox"/>	The refrigerant pipes (gas and liquid) are thermally insulated.
<input type="checkbox"/>	The correct pipe size is installed and the pipes are properly insulated.
<input type="checkbox"/>	There is NO water leak inside the indoor unit.
<input type="checkbox"/>	The stop valves (gas and liquid) on the outdoor and indoor units are fully open.
<input type="checkbox"/>	The domestic hot water tank is filled completely.

8.2 Checklist during commissioning

<input type="checkbox"/>	To perform an actuator test run .
<input type="checkbox"/>	To perform a test run .

8.2.1 To perform an actuator test run

Purpose

Perform an actuator test run to confirm the operation of the different actuators. For example, when you select Booster heater, a test run of the booster heater will start.

Conditions: Make sure all operation is disabled. Go to [C]: Operation and turn off Tank operation.

1	Set the user permission level to Installer. See " To change the user permission level " [▶ 13].	—
2	Go to [A.2]: Commissioning > Actuator test run.	
3	Select Booster heater.	
4	Select OK to confirm. Result: The actuator test run starts. It stops automatically when ready (±30 min). To stop the test run manually:	
1	In the menu, go to Stop test run.	
2	Select OK to confirm.	

Possible actuator test runs

- Booster heater test

8.2.2 To perform an operation test run

Conditions: Make sure all operation is disabled. Go to [C]: Operation and turn off Tank operation.

1	Set the user permission level to Installer. See " To change the user permission level " [▶ 13].	—
2	Go to [A.1]: Commissioning > Operation test run.	
3	Select the Tank.	
4	Select OK to confirm. Result: The test run starts. It stops automatically when ready (±30 min). To stop the test run manually:	
1	In the menu, go to Stop test run.	
2	Select OK to confirm.	





INFORMATION

If the outdoor temperature is outside the range of operation, the unit may NOT operate or may NOT deliver the required capacity.

To monitor tank temperatures

During test run, the correct operation of the unit can be checked by monitoring its tank temperature (domestic hot water mode).

To monitor the temperatures:

1	In the menu, go to Sensors.	
2	Select the temperature information.	

9 Hand-over to the user

Once the test run is finished and the unit operates properly, make sure the following is clear for the user:

- Fill in the installer setting table (in the operation manual) with the actual settings.
- Make sure that the user has the printed documentation and ask him/her to keep it for future reference. Inform the user that he/she can find the complete documentation at the URL mentioned earlier in this manual.
- Explain to the user how to properly operate the system and what to do in case of problems.
- Show the user what to do for the maintenance of the unit.
- Explain about energy saving tips to the user as described in the operation manual.

10 Technical data

10 Technical data

A **subset** of the latest technical data is available on the regional Daikin website (publicly accessible). The **full set** of the latest technical data is available on the Daikin Business Portal (authentication required).

10.1 Piping diagram: Indoor unit

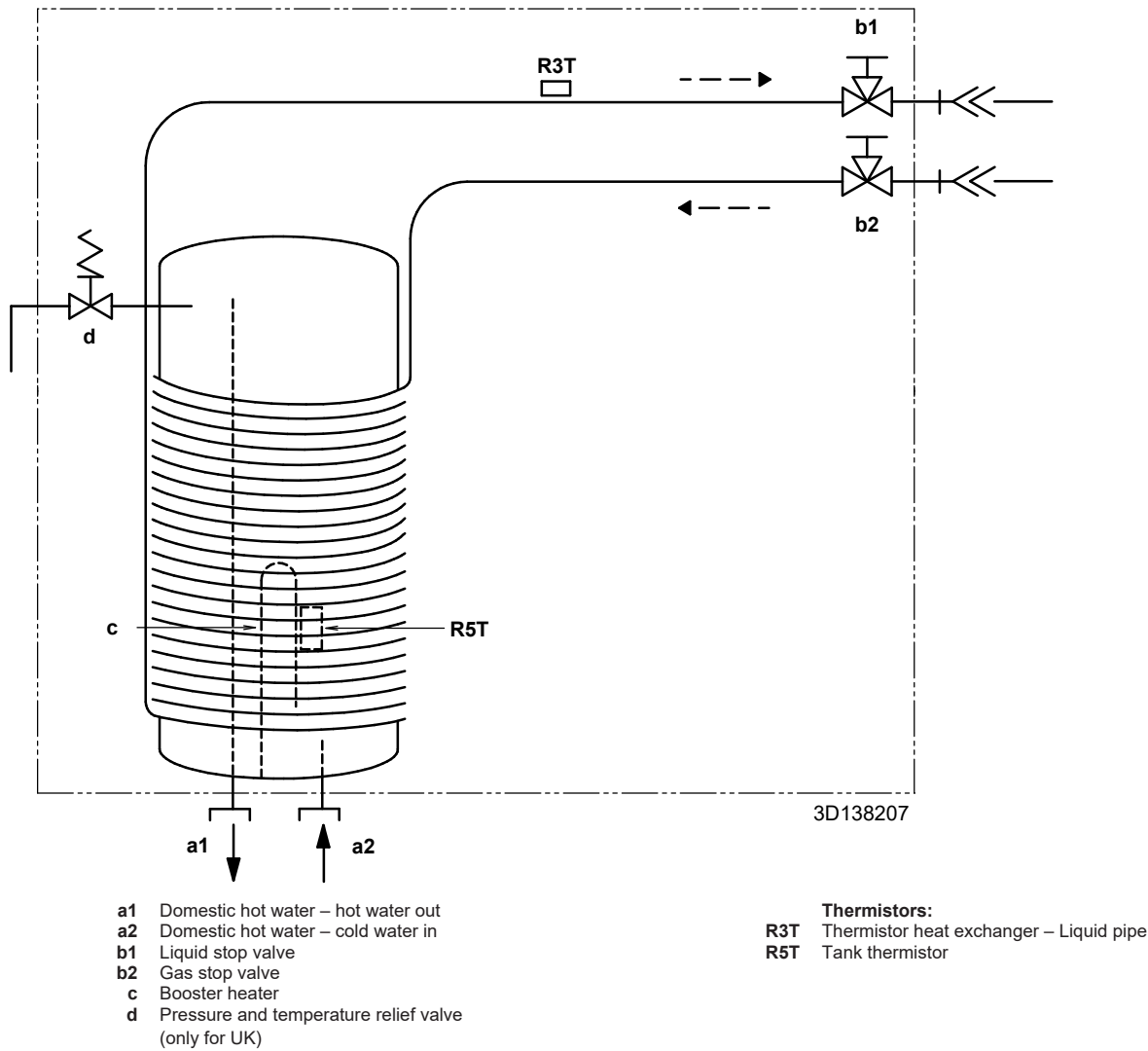

10.2 Wiring diagram: Indoor unit

See the internal wiring diagram supplied with the unit (on the inside of the indoor unit switch box cover). The abbreviations used are listed below.

Legend

A1P		Main PCB
F2B	#	Overcurrent fuse booster heater
FU1 (A1P)		Fuse (5 A 250 V for PCB)
K3M		Contactor booster heater
Q1DI	#	Earth leakage circuit breaker
TR1		Power supply transformer
X4M	#	Booster heater power supply terminal strip client
X8M		Booster heater power supply terminal strip
X*, X*A, X*B		Connector
X*M		Terminal strip

- * Optional
- # Field supply

Translation of text on wiring diagram

English	Translation
(1) Connection diagram	(1) Connection diagram
Compressor switch box	Compressor switch box
Multi+DHW Tank switch box	Multi domestic hot water tank switch box
Indoor	Indoor
Outdoor	Outdoor
SWB	Switch box
(2) Legend	(2) Legend
A1P	Main PCB
F2B	Overcurrent fuse booster heater
FU1 (A1P)	fuse (5 A 250 V for PCB)

K3M	Contactor booster heater
Q1DI	Earth leakage circuit breaker
TR1	Power supply transformer
X4M	Booster heater power supply terminal strip client
X8M	Booster heater power supply terminal strip
X*, X*A, X*B	Connector
X*M	Terminal strip
(3) Notes	(3) Notes
X2M	Field wiring terminal for AC
X4M	Booster heater power supply terminal strip client
X5M	Field wiring terminal for AC (Outdoor)
X8M	Booster heater power supply terminal strip
---	Earth wiring
---	Field supply
[Dashed Box]	Option
[Dashed Box]	Not mounted in switch box
[Dashed Box]	Wiring depending on model
[Rectangle]	PCB
Note 1: Connection point of the power supply for the BSH should be foreseen outside the unit	Note 1: Connection point of the power supply for the booster heater should be foreseen outside the unit.
(4) Switch box layout	(4) Switch box layout
SWB	Switch box

Electrical connection diagram

For more details, please check the unit wiring.

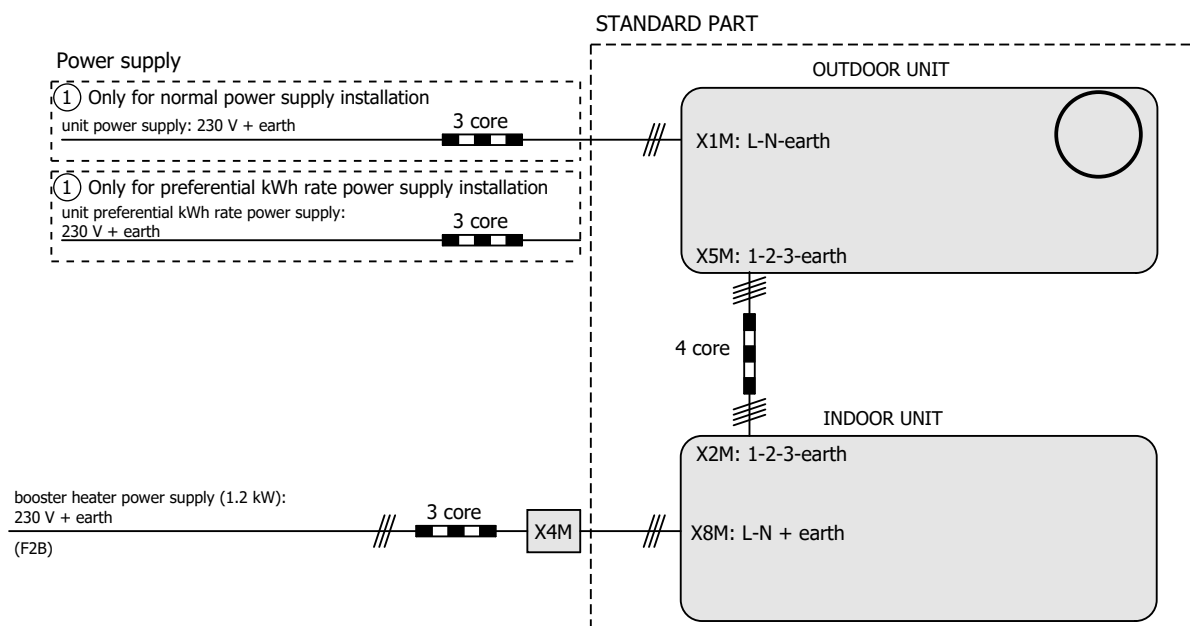



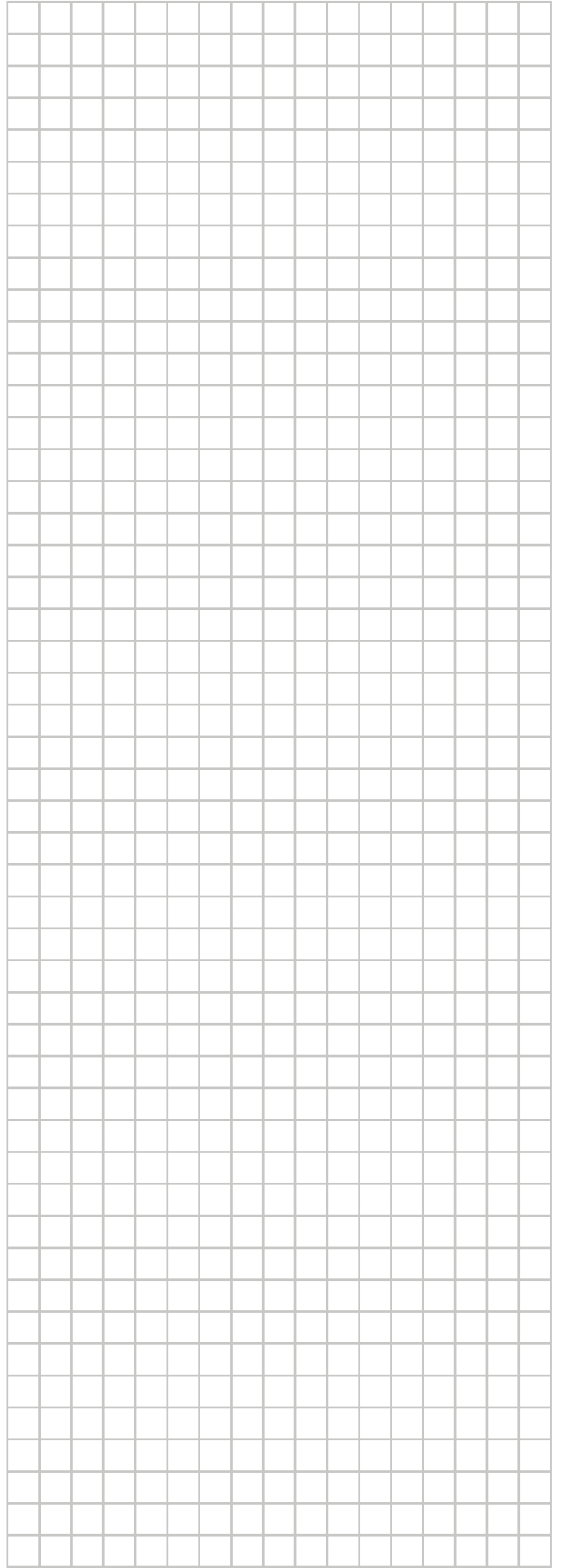



4P680074-1 E 0000000%

Copyright 2021 Daikin

DAIKIN EUROPE N.V.

Zandvoordestraat 300, B-8400 Oostende, Belgium

4P680074-1E 2025.09